

## FEATURES

- **Controlled Baseline**
  - One Assembly/Test Site, One Fabrication Site
- **Extended Temperature Performance of –55°C to 125°C**
- **Enhanced Diminishing Manufacturing Sources (DMS) Support**
- **Enhanced Product-Change Notification**
- **Qualification Pedigree <sup>(1)</sup>**
- **Meets or Exceeds the Requirements of ANSI TIA/EIA-422-B, TIA/EIA-423-B, and ITU Recommendations V.10 and V.11**
- **±7-V Common-Mode Range With ±200-mV Sensitivity**
- **Input Hysteresis . . . 50 mV Typ**
- **Operates From a Single 5-V Supply**
- **Low-Power Schottky Circuitry**
- **3-State Outputs**
- **Complementary Output-Enable Inputs**
- **Input Impedance . . . 12 kΩ Min**
- **Designed to Be Interchangeable With Advanced Micro Devices AM26LS32**

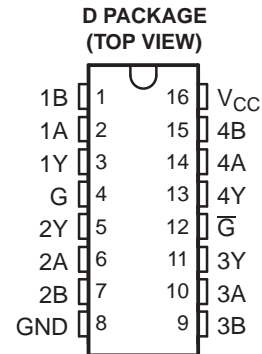

- (1) Component qualification in accordance with JEDEC and industry standards to ensure reliable operation over an extended temperature range. This includes, but is not limited to, Highly Accelerated Stress Test (HAST) or biased 85/85, temperature cycle, autoclave or unbiased HAST, electromigration, bond intermetallic life, and mold compound life. Such qualification testing should not be viewed as justifying use of this component beyond specified performance and environmental limits.

## DESCRIPTION/ORDERING INFORMATION

The AM26LS32A is a quadruple differential line receiver for balanced and unbalanced digital data transmission. The enable function is common to all four receivers and offers a choice of active-high or active-low input. The 3-state outputs permit connection directly to a bus-organized system. Fail-safe design ensures that, if the inputs are open, the outputs always are high.

The AM26LS32A incorporates an additional stage of amplification to improve sensitivity. The input impedance has been increased, resulting in less loading of the bus line. The additional stage has increased propagation delay, however, this does not affect interchangeability in most applications.

The AM26LS32AM is characterized for operation over the full military temperature range of –55°C to 125°C.

### ORDERING INFORMATION

T <sub>A</sub>	PACKAGE <sup>(1)</sup>		ORDERABLE PART NUMBER	TOP-SIDE MARKING
–55°C to 125°C	SOIC – D	Tape and reel	AM26LS32AMDREP	26LS32EP

- (1) Package drawings, standard packing quantities, thermal data, symbolization, and PCB design guidelines are available at [www.ti.com/sc/package](http://www.ti.com/sc/package).



Please be aware that an important notice concerning availability, standard warranty, and use in critical applications of Texas Instruments semiconductor products and disclaimers thereto appears at the end of this data sheet.

FUNCTION TABLE<sup>(1)</sup>  
 (each receiver)

DIFFERENTIAL A – B	ENABLES		OUTPUT Y
	G	$\bar{G}$	
$V_{ID} \geq V_{IT+}$	H	X	H
	X	L	H
$V_{IT-} \leq V_{ID} \leq V_{IT+}$	H	X	?
	X	L	?
$V_{ID} \leq V_{IT-}$	H	X	L
	X	L	L
X	L	H	Z
Open	H	X	H
	X	L	H

(1) H = high level, L = low level, ? = indeterminate, X = irrelevant,  
 Z = high impedance (off)

LOGIC DIAGRAM (POSITIVE LOGIC)

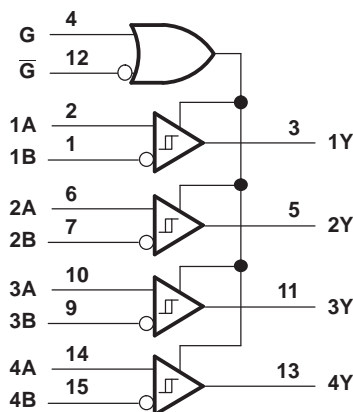

SCHEMATICS OF INPUTS AND OUTPUTS

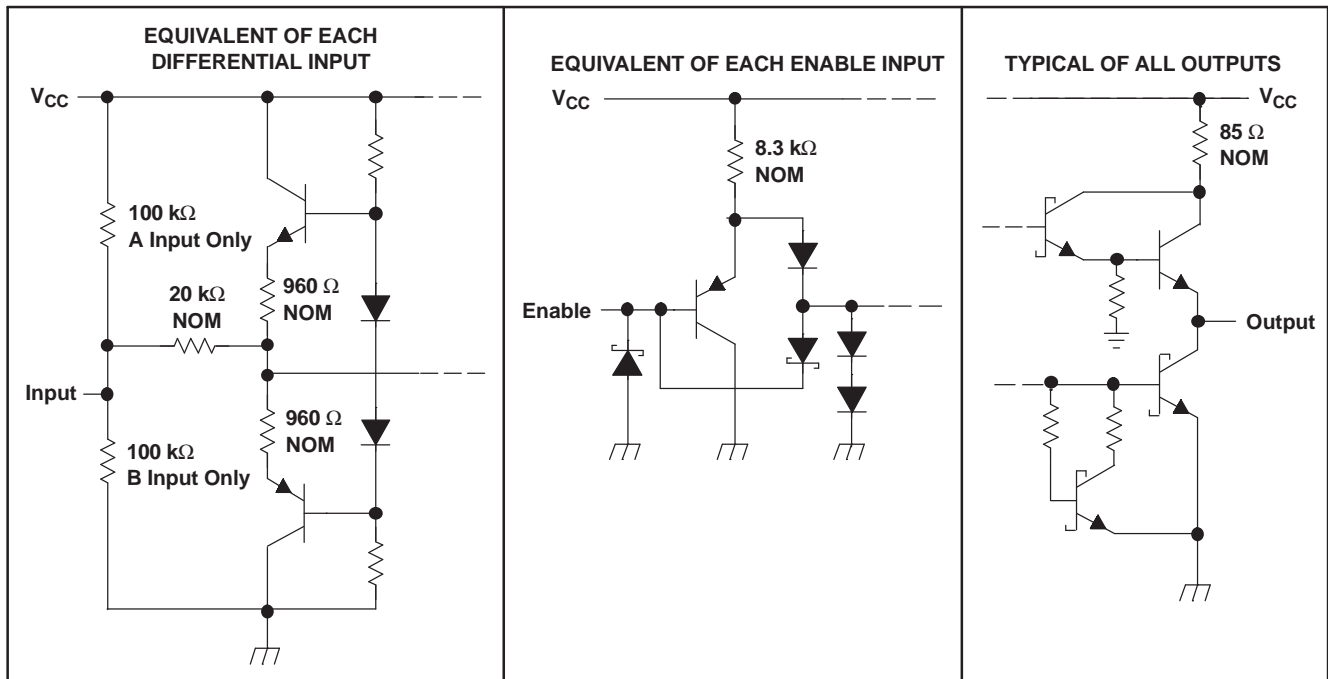

**Absolute Maximum Ratings**<sup>(1)</sup>

over operating free-air temperature range (unless otherwise noted)

		MIN	MAX	UNIT	
$V_{CC}$	Supply voltage <sup>(2)</sup>		7	V	
$V_I$	Input voltage	Any differential input		±25	V
		Other inputs		7	
$V_{ID}$	Differential input voltage <sup>(3)</sup>		±25	V	
Continuous total power dissipation				See Dissipation Rating Table	
$\theta_{JA}$	Package thermal impedance <sup>(4)</sup>	D package		111.6	°C/W
$T_{stg}$	Storage temperature range <sup>(5)</sup>	-65	150	°C	

- (1) Stresses beyond those listed under "absolute maximum ratings" may cause permanent damage to the device. These are stress ratings only, and functional operation of the device at these or any other conditions beyond those indicated under "recommended operating conditions" is not implied. Exposure to absolute-maximum-rated conditions for extended periods may affect device reliability.
- (2) All voltage values, except differential voltages, are with respect to the network ground terminal.
- (3) Differential voltage values are at the noninverting (A) input terminals with respect to the inverting (B) input terminals.
- (4) The package thermal impedance is calculated in accordance with JESD 51-7.
- (5) Long-term high-temperature storage and/or extended use at maximum recommended operating conditions may result in a reduction of overall device life. See [http://www.ti.com/ep\\_quality](http://www.ti.com/ep_quality) for additional information on enhanced plastic packaging.

DISSIPATION RATING TABLE

PACKAGE	$T_A \leq 25^\circ\text{C}$ POWER RATING	DERATING FACTOR ABOVE $T_A = 25^\circ\text{C}$	$T_A = 70^\circ\text{C}$ POWER RATING	$T_A = 125^\circ\text{C}$ POWER RATING
D	1075 mW	8.9 mW/°C	672 mW	179 mW

# AM26LS32AM-EP QUADRUPLE DIFFERENTIAL LINE RECEIVER

SLLS730–OCTOBER 2006

## Recommended Operating Conditions

		MIN	NOM	MAX	UNIT
$V_{CC}$	Supply voltage	4.5	5	5.5	V
$V_{IH}$	High-level input voltage	2			V
$V_{IL}$	Low-level input voltage			0.8	V
$V_{IC}$	Common-mode input voltage			$\pm 7$	V
$I_{OH}$	High-level output current			-440	$\mu$ A
$I_{OL}$	Low-level output current			8	mA
$T_A$	Operating free-air temperature	-55		125	$^{\circ}$ C

## Electrical Characteristics

over recommended ranges of  $V_{CC}$ ,  $V_{IC}$ , and operating free-air temperature (unless otherwise noted)

PARAMETER	TEST CONDITIONS	MIN	TYP <sup>(1)</sup>	MAX	UNIT
$V_{IT+}$	Positive-going input threshold voltage $V_O = V_{OH} \text{ min, } I_{OH} = -440 \mu\text{A}$			0.2	V
$V_{IT-}$	Negative-going input threshold voltage $V_O = 0.45 \text{ V, } I_{OL} = 8 \text{ mA}$	-0.2 <sup>(2)</sup>			V
$V_{hys}$	Hysteresis voltage ( $V_{IT+} - V_{IT-}$ )		50		mV
$V_{IK}$	Enable-input clamp voltage $V_{CC} = \text{MIN, } I_I = -18 \text{ mA}$			-1.5	V
$V_{OH}$	High-level output voltage $V_{CC} = \text{MIN, } V_{ID} = 1 \text{ V, } V_{I(G)} = 0.8 \text{ V, } I_{OH} = -440 \mu\text{A}$	2.5			V
$V_{OL}$	Low-level output voltage $V_{CC} = \text{MIN, } V_{ID} = -1 \text{ V, } V_{I(G)} = 0.8 \text{ V}$	$I_{OL} = 4 \text{ mA}$		0.4	V
		$I_{OL} = 8 \text{ mA}$		0.45	
$I_{OZ}$	Off-state (high-impedance state) output current $V_{CC} = \text{MAX}$	$V_O = 2.4 \text{ V}$		20	$\mu$ A
		$V_O = 0.4 \text{ V}$		-20	
$I_I$	Line input current $V_I = 15 \text{ V, } \text{Other input at } -10 \text{ V to } 15 \text{ V}$ $V_I = -15 \text{ V, } \text{Other input at } -15 \text{ V to } 10 \text{ V}$			1.2	mA
				-1.7	
$I_{I(EN)}$	Enable input current $V_I = 5.5 \text{ V}$			100	$\mu$ A
$I_{IH}$	High-level enable current $V_I = 2.7 \text{ V}$			20	$\mu$ A
$I_{IL}$	Low-level enable current $V_I = 0.4 \text{ V}$			-0.36	mA
$r_I$	Input resistance $V_{IC} = -15 \text{ V to } 15 \text{ V, } \text{One input to ac ground}$	12	15		k $\Omega$
$I_{OS}$	Short-circuit output current <sup>(3)</sup> $V_{CC} = \text{MAX}$	-15		-85	mA
$I_{CC}$	Supply current $V_{CC} = \text{MAX, } \text{All outputs disabled}$		52	70	mA

(1) All typical values are at  $V_{CC} = 5 \text{ V, } T_A = 25^{\circ}\text{C,}$  and  $V_{IC} = 0$ .

(2) The algebraic convention, in which the less positive (more negative) limit is designated as minimum, is used in this data sheet for threshold levels only.

(3) Not more than one output should be shorted to ground at a time, and duration of the short circuit should not exceed one second.

## Switching Characteristics

$V_{CC} = 5\text{ V}$ ,  $T_A = 25^\circ\text{C}$

PARAMETER		TEST CONDITIONS		MIN	TYP	MAX	UNIT
$t_{PLH}$	Propagation delay time, low-to-high-level output	$C_L = 15\text{ pF}$ ,	See <a href="#">Figure 1</a>		20	35	ns
$t_{PHL}$	Propagation delay time, high-to-low-level output				22	35	
$t_{PZH}$	Output enable time to high level	$C_L = 15\text{ pF}$ ,	See <a href="#">Figure 1</a>		17	22	ns
$t_{PZL}$	Output enable time to low level				20	25	
$t_{PHZ}$	Output disable time from high level	$C_L = 5\text{ pF}$ ,	See <a href="#">Figure 1</a>		21	30	ns
$t_{PLZ}$	Output disable time from low level				30	40	

PARAMETER MEASUREMENT INFORMATION

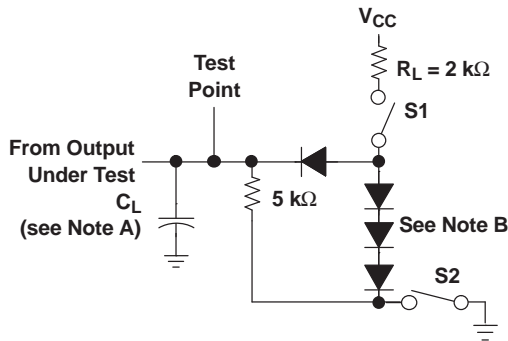

TEST CIRCUIT

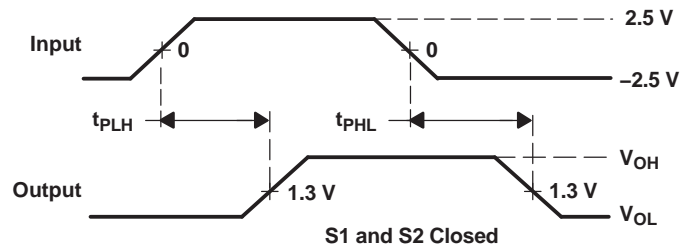

VOLTAGE WAVEFORMS FOR  $t_{PLH}$ ,  $t_{PHL}$

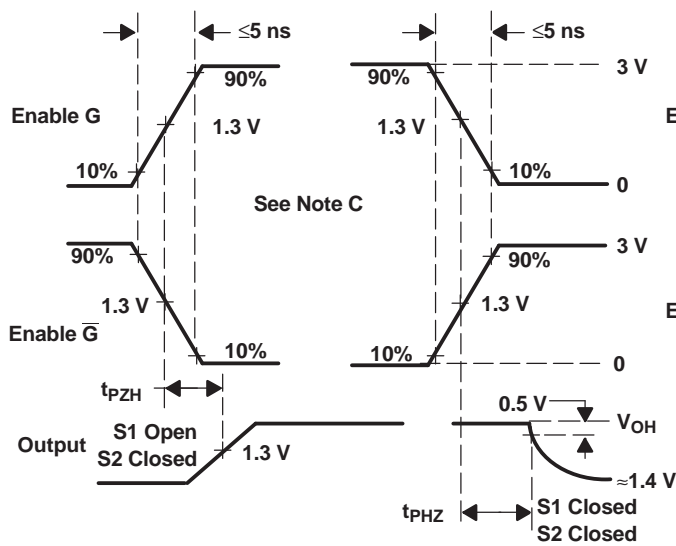

VOLTAGE WAVEFORMS FOR  $t_{PHZ}$ ,  $t_{PZH}$

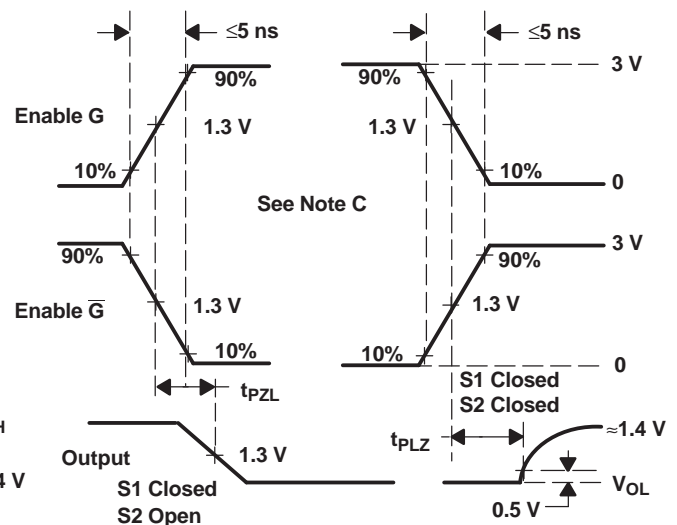

VOLTAGE WAVEFORMS FOR  $t_{PLZ}$ ,  $t_{PZL}$

- NOTES: A.  $C_L$  includes probe and jig capacitance.  
 B. All diodes are 1N3064 or equivalent.  
 C. Enable G is tested with  $\bar{G}$  high;  $\bar{G}$  is tested with G low.

Figure 1. Test Circuit and Voltage Waveforms

TYPICAL CHARACTERISTICS

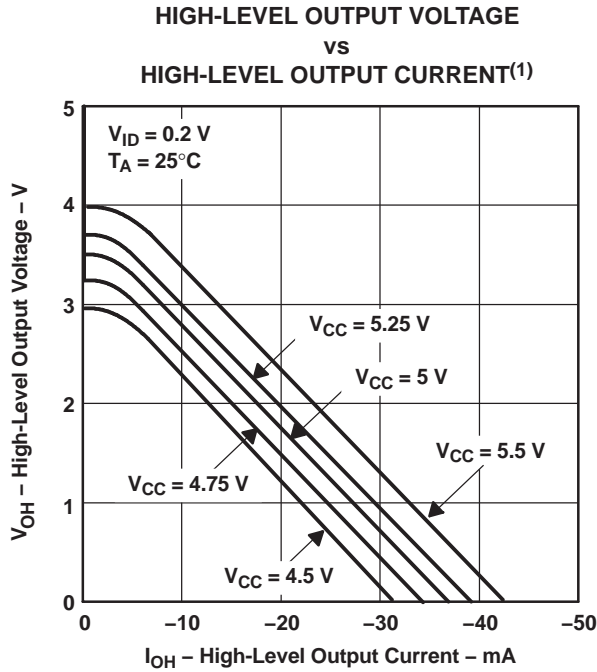

(1)  $V_{CC} = 5.5$  V and  $V_{CC} = 4.5$  V applies to M-suffix devices only.

Figure 2.

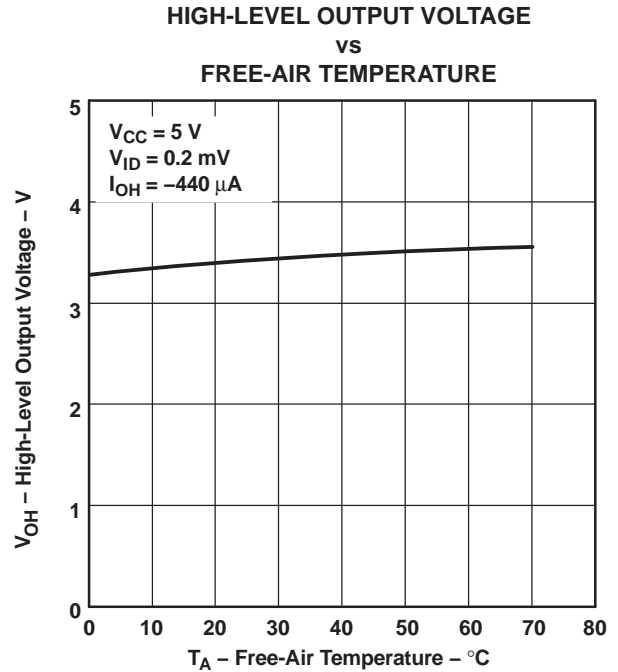

Figure 3.

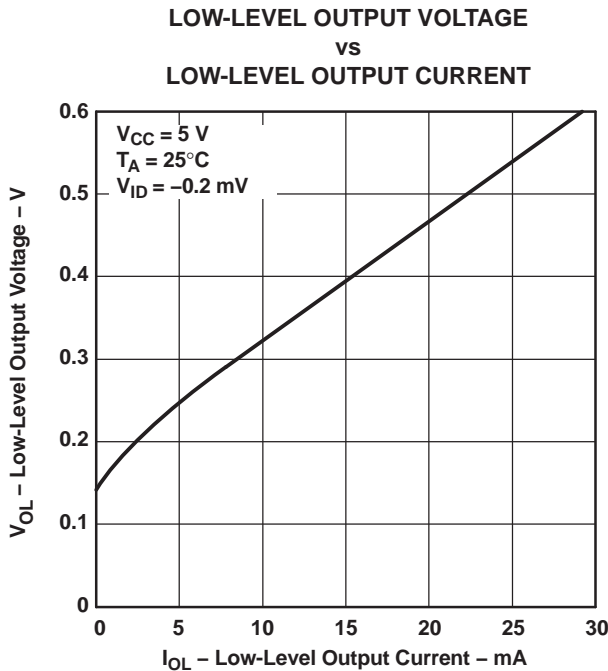

Figure 4.

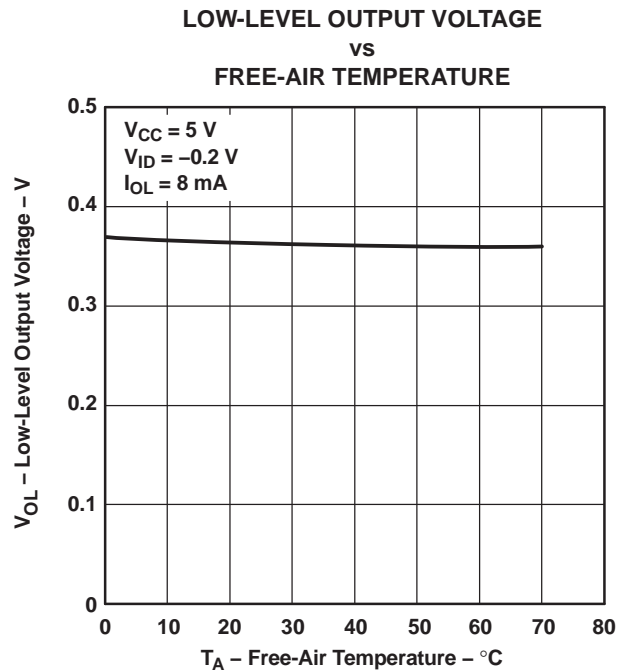

Figure 5.

TYPICAL CHARACTERISTICS (continued)

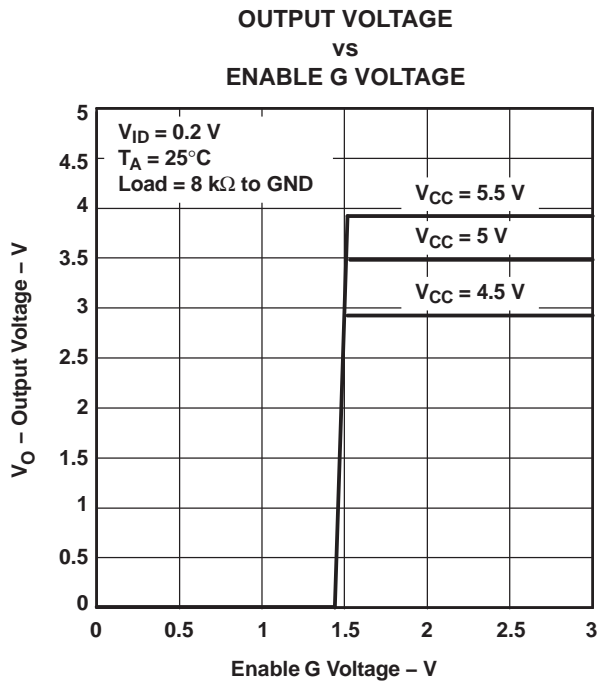

Figure 6.

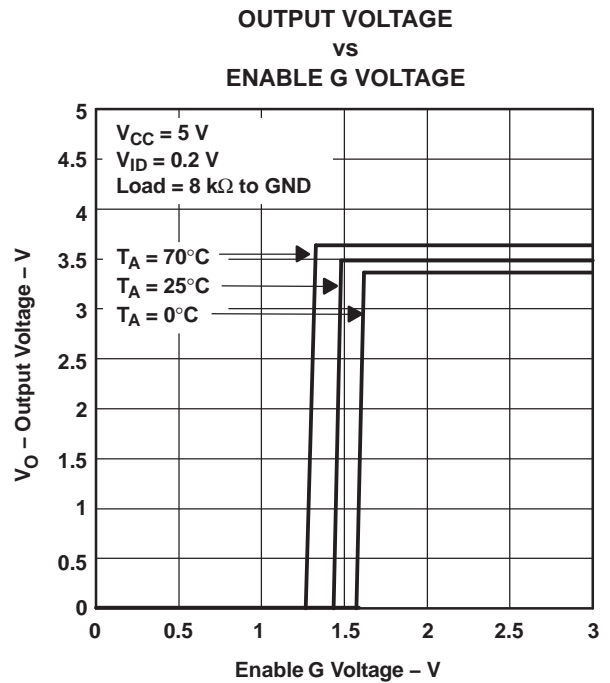

Figure 7.

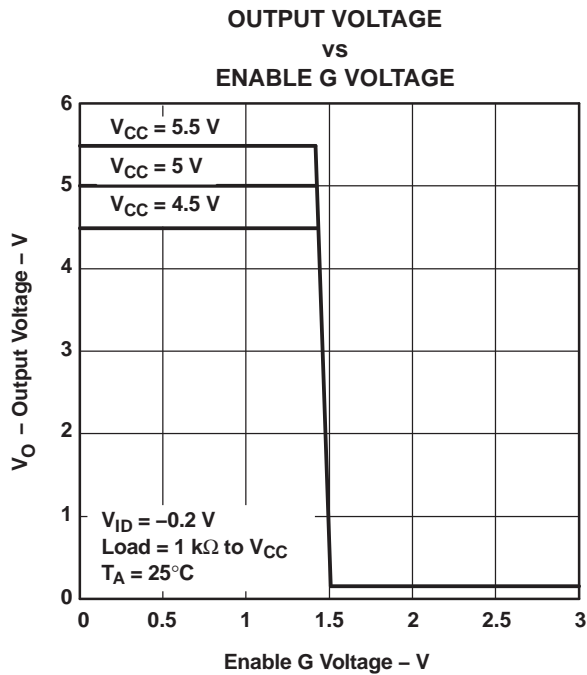

Figure 8.

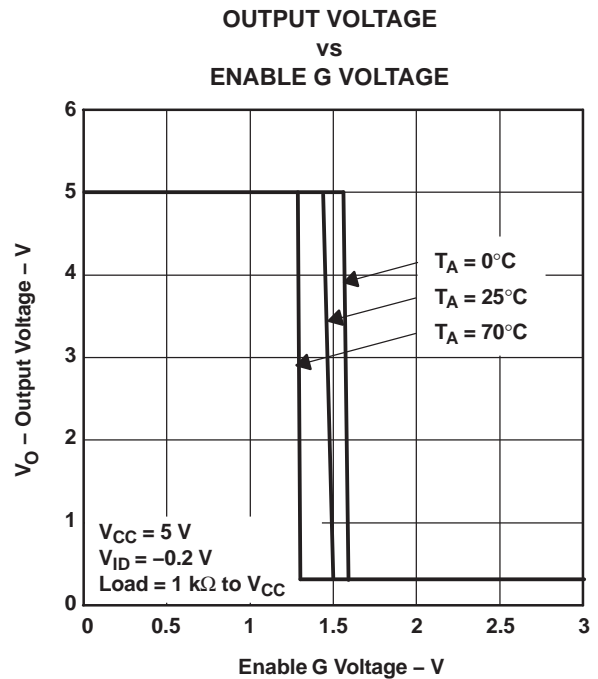
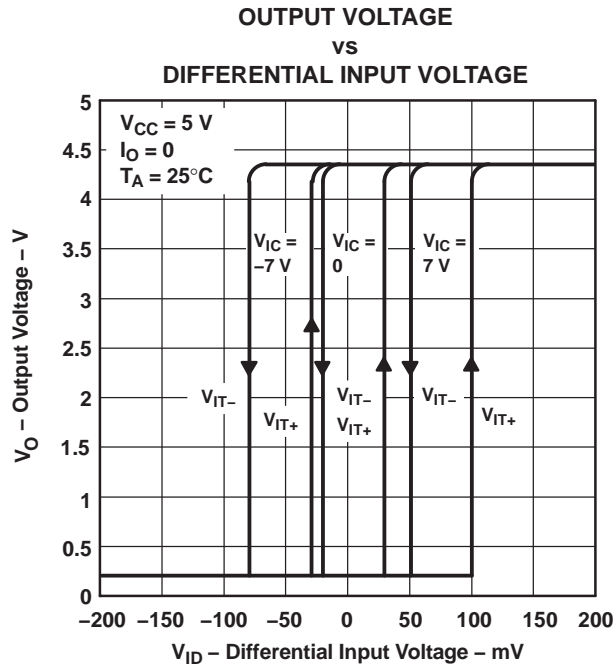

Figure 9.



**TYPICAL CHARACTERISTICS (continued)**



**Figure 10.**

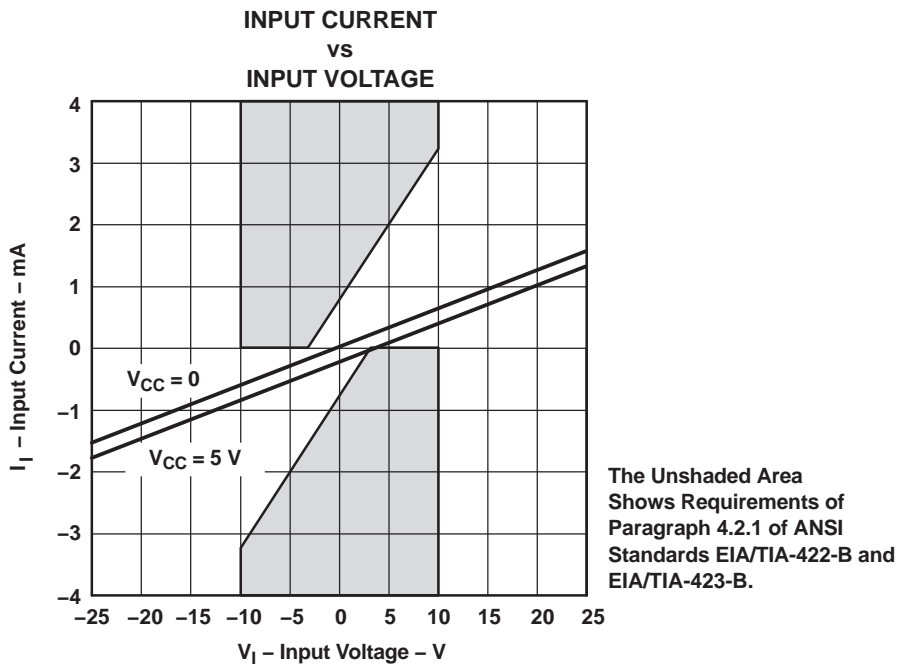

**Figure 11.**

**PACKAGING INFORMATION**

Orderable Device	Status <sup>(1)</sup>	Package Type	Package Drawing	Pins	Package Qty	Eco Plan <sup>(2)</sup>	Lead/Ball Finish	MSL Peak Temp <sup>(3)</sup>
AM26LS32AMDREP	ACTIVE	SOIC	D	16	2500	Green (RoHS & no Sb/Br)	CU NIPDAU	Level-1-260C-UNLIM
V62/07603-01XE	ACTIVE	SOIC	D	16	2500	Green (RoHS & no Sb/Br)	CU NIPDAU	Level-1-260C-UNLIM

<sup>(1)</sup> The marketing status values are defined as follows:

**ACTIVE:** Product device recommended for new designs.

**LIFEBUY:** TI has announced that the device will be discontinued, and a lifetime-buy period is in effect.

**NRND:** Not recommended for new designs. Device is in production to support existing customers, but TI does not recommend using this part in a new design.

**PREVIEW:** Device has been announced but is not in production. Samples may or may not be available.

**OBsolete:** TI has discontinued the production of the device.

<sup>(2)</sup> Eco Plan - The planned eco-friendly classification: Pb-Free (RoHS), Pb-Free (RoHS Exempt), or Green (RoHS & no Sb/Br) - please check <http://www.ti.com/productcontent> for the latest availability information and additional product content details.

**TBD:** The Pb-Free/Green conversion plan has not been defined.

**Pb-Free (RoHS):** TI's terms "Lead-Free" or "Pb-Free" mean semiconductor products that are compatible with the current RoHS requirements for all 6 substances, including the requirement that lead not exceed 0.1% by weight in homogeneous materials. Where designed to be soldered at high temperatures, TI Pb-Free products are suitable for use in specified lead-free processes.

**Pb-Free (RoHS Exempt):** This component has a RoHS exemption for either 1) lead-based flip-chip solder bumps used between the die and package, or 2) lead-based die adhesive used between the die and leadframe. The component is otherwise considered Pb-Free (RoHS compatible) as defined above.

**Green (RoHS & no Sb/Br):** TI defines "Green" to mean Pb-Free (RoHS compatible), and free of Bromine (Br) and Antimony (Sb) based flame retardants (Br or Sb do not exceed 0.1% by weight in homogeneous material)

<sup>(3)</sup> MSL, Peak Temp. -- The Moisture Sensitivity Level rating according to the JEDEC industry standard classifications, and peak solder temperature.

**Important Information and Disclaimer:**The information provided on this page represents TI's knowledge and belief as of the date that it is provided. TI bases its knowledge and belief on information provided by third parties, and makes no representation or warranty as to the accuracy of such information. Efforts are underway to better integrate information from third parties. TI has taken and continues to take reasonable steps to provide representative and accurate information but may not have conducted destructive testing or chemical analysis on incoming materials and chemicals. TI and TI suppliers consider certain information to be proprietary, and thus CAS numbers and other limited information may not be available for release.

In no event shall TI's liability arising out of such information exceed the total purchase price of the TI part(s) at issue in this document sold by TI to Customer on an annual basis.

**OTHER QUALIFIED VERSIONS OF AM26LS32AM-EP :**

- Catalog: [AM26LS32AM](#)

NOTE: Qualified Version Definitions:

- Catalog - TI's standard catalog product

D (R-PDSO-G16)

PLASTIC SMALL-OUTLINE PACKAGE

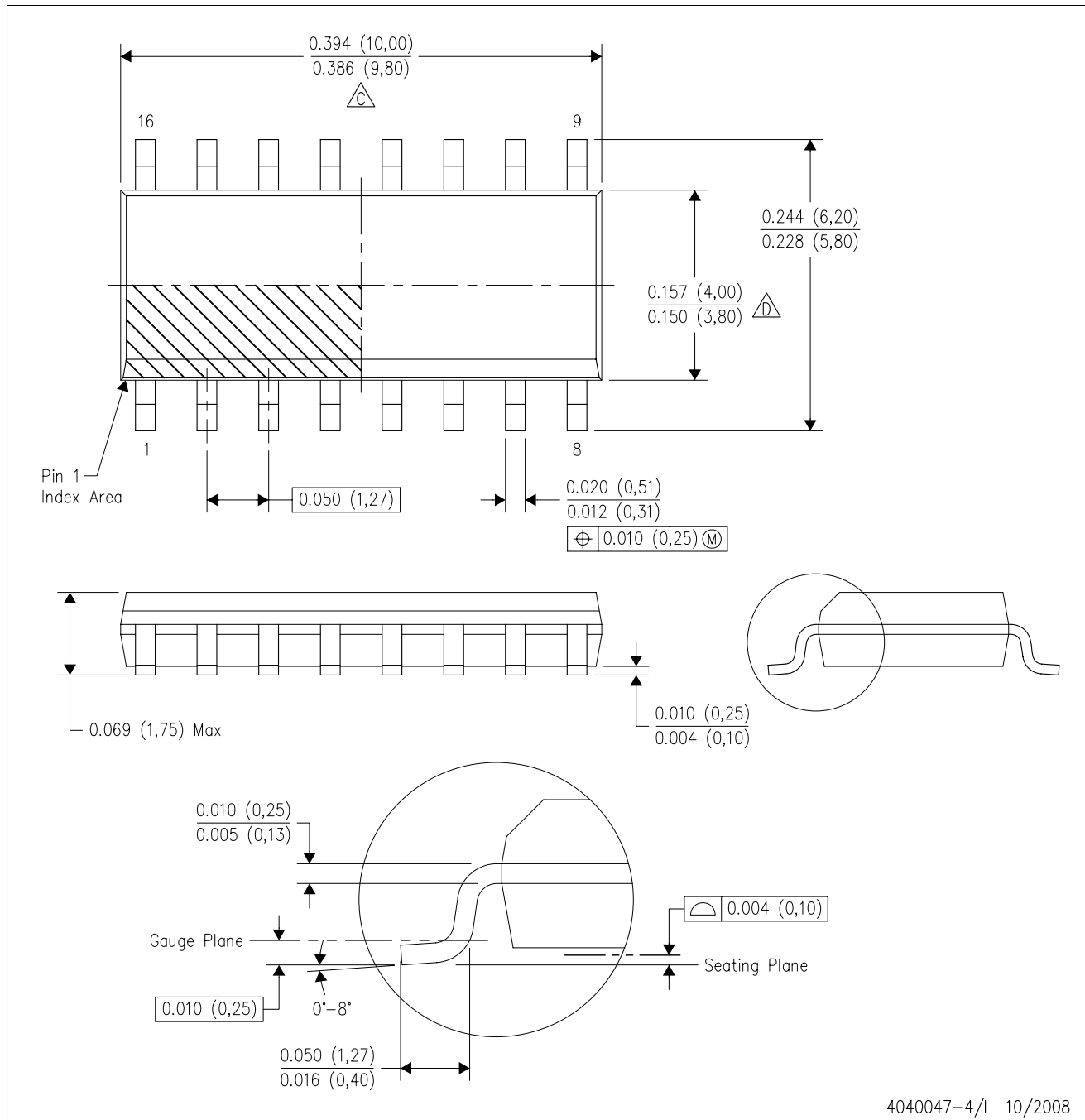

- NOTES:
- A. All linear dimensions are in inches (millimeters).
  - B. This drawing is subject to change without notice.
  - C. Body length does not include mold flash, protrusions, or gate burrs. Mold flash, protrusions, or gate burrs shall not exceed .006 (0,15) per end.
  - D. Body width does not include interlead flash. Interlead flash shall not exceed .017 (0,43) per side.
  - E. Reference JEDEC MS-012 variation AC.

D(R-PDSO-G16)

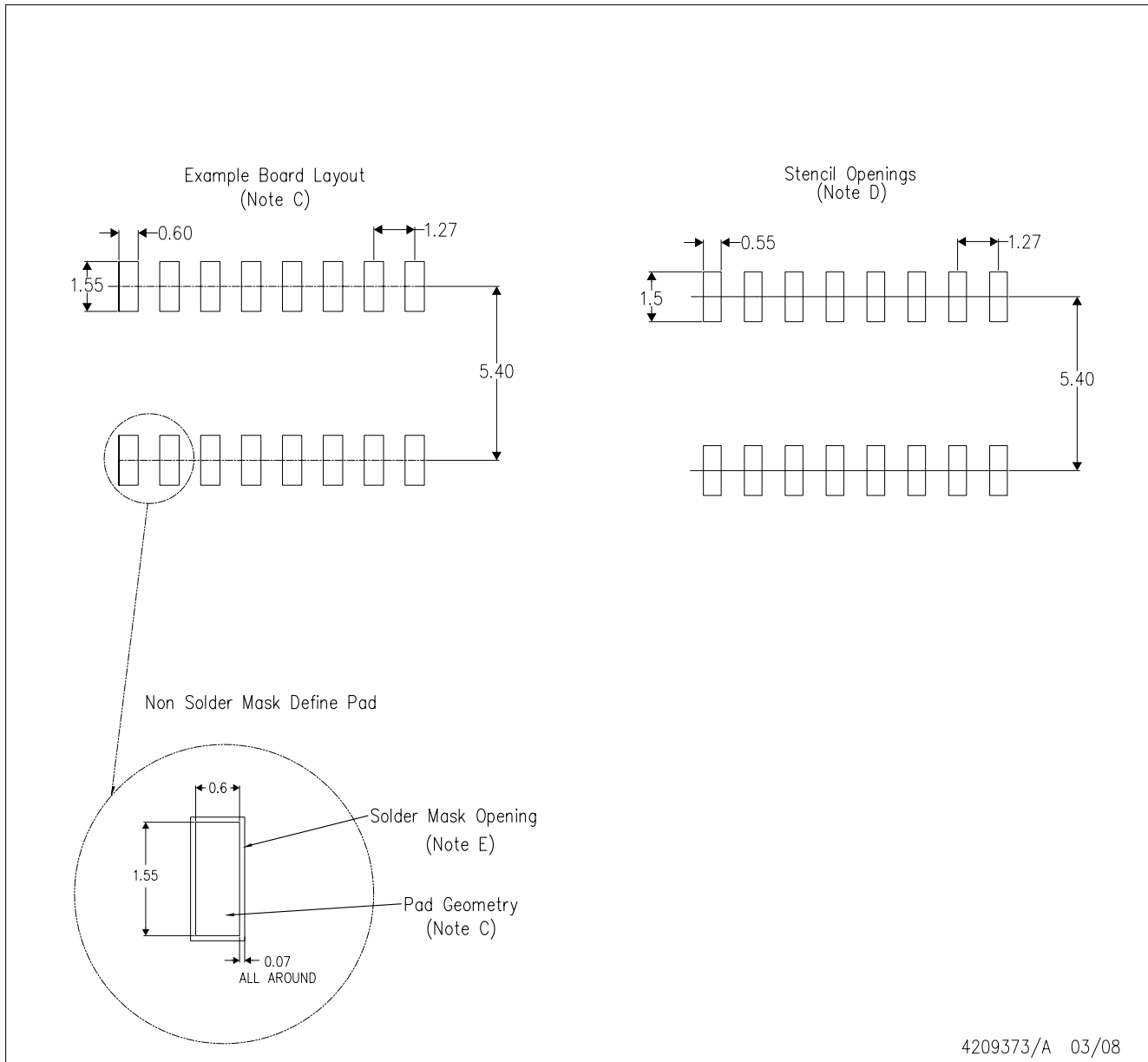

4209373/A 03/08

- NOTES:
- A. All linear dimensions are in millimeters.
  - B. This drawing is subject to change without notice.
  - C. Refer to IPC7351 for alternate board design.
  - D. Laser cutting apertures with trapezoidal walls and also rounding corners will offer better paste release. Customers should contact their board assembly site for stencil design recommendations. Refer to IPC-7525
  - E. Customers should contact their board fabrication site for solder mask tolerances between and around signal pads.

## IMPORTANT NOTICE

Texas Instruments Incorporated and its subsidiaries (TI) reserve the right to make corrections, modifications, enhancements, improvements, and other changes to its products and services at any time and to discontinue any product or service without notice. Customers should obtain the latest relevant information before placing orders and should verify that such information is current and complete. All products are sold subject to TI's terms and conditions of sale supplied at the time of order acknowledgment.

TI warrants performance of its hardware products to the specifications applicable at the time of sale in accordance with TI's standard warranty. Testing and other quality control techniques are used to the extent TI deems necessary to support this warranty. Except where mandated by government requirements, testing of all parameters of each product is not necessarily performed.

TI assumes no liability for applications assistance or customer product design. Customers are responsible for their products and applications using TI components. To minimize the risks associated with customer products and applications, customers should provide adequate design and operating safeguards.

TI does not warrant or represent that any license, either express or implied, is granted under any TI patent right, copyright, mask work right, or other TI intellectual property right relating to any combination, machine, or process in which TI products or services are used. Information published by TI regarding third-party products or services does not constitute a license from TI to use such products or services or a warranty or endorsement thereof. Use of such information may require a license from a third party under the patents or other intellectual property of the third party, or a license from TI under the patents or other intellectual property of TI.

Reproduction of TI information in TI data books or data sheets is permissible only if reproduction is without alteration and is accompanied by all associated warranties, conditions, limitations, and notices. Reproduction of this information with alteration is an unfair and deceptive business practice. TI is not responsible or liable for such altered documentation. Information of third parties may be subject to additional restrictions.

Resale of TI products or services with statements different from or beyond the parameters stated by TI for that product or service voids all express and any implied warranties for the associated TI product or service and is an unfair and deceptive business practice. TI is not responsible or liable for any such statements.

TI products are not authorized for use in safety-critical applications (such as life support) where a failure of the TI product would reasonably be expected to cause severe personal injury or death, unless officers of the parties have executed an agreement specifically governing such use. Buyers represent that they have all necessary expertise in the safety and regulatory ramifications of their applications, and acknowledge and agree that they are solely responsible for all legal, regulatory and safety-related requirements concerning their products and any use of TI products in such safety-critical applications, notwithstanding any applications-related information or support that may be provided by TI. Further, Buyers must fully indemnify TI and its representatives against any damages arising out of the use of TI products in such safety-critical applications.

TI products are neither designed nor intended for use in military/aerospace applications or environments unless the TI products are specifically designated by TI as military-grade or "enhanced plastic." Only products designated by TI as military-grade meet military specifications. Buyers acknowledge and agree that any such use of TI products which TI has not designated as military-grade is solely at the Buyer's risk, and that they are solely responsible for compliance with all legal and regulatory requirements in connection with such use.

TI products are neither designed nor intended for use in automotive applications or environments unless the specific TI products are designated by TI as compliant with ISO/TS 16949 requirements. Buyers acknowledge and agree that, if they use any non-designated products in automotive applications, TI will not be responsible for any failure to meet such requirements.

Following are URLs where you can obtain information on other Texas Instruments products and application solutions:

### Products

Amplifiers	<a href="http://amplifier.ti.com">amplifier.ti.com</a>
Data Converters	<a href="http://dataconverter.ti.com">dataconverter.ti.com</a>
DSP	<a href="http://dsp.ti.com">dsp.ti.com</a>
Clocks and Timers	<a href="http://www.ti.com/clocks">www.ti.com/clocks</a>
Interface	<a href="http://interface.ti.com">interface.ti.com</a>
Logic	<a href="http://logic.ti.com">logic.ti.com</a>
Power Mgmt	<a href="http://power.ti.com">power.ti.com</a>
Microcontrollers	<a href="http://microcontroller.ti.com">microcontroller.ti.com</a>
RFID	<a href="http://www.ti-rfid.com">www.ti-rfid.com</a>
RF/IF and ZigBee® Solutions	<a href="http://www.ti.com/lprf">www.ti.com/lprf</a>

### Applications

Audio	<a href="http://www.ti.com/audio">www.ti.com/audio</a>
Automotive	<a href="http://www.ti.com/automotive">www.ti.com/automotive</a>
Broadband	<a href="http://www.ti.com/broadband">www.ti.com/broadband</a>
Digital Control	<a href="http://www.ti.com/digitalcontrol">www.ti.com/digitalcontrol</a>
Medical	<a href="http://www.ti.com/medical">www.ti.com/medical</a>
Military	<a href="http://www.ti.com/military">www.ti.com/military</a>
Optical Networking	<a href="http://www.ti.com/opticalnetwork">www.ti.com/opticalnetwork</a>
Security	<a href="http://www.ti.com/security">www.ti.com/security</a>
Telephony	<a href="http://www.ti.com/telephony">www.ti.com/telephony</a>
Video & Imaging	<a href="http://www.ti.com/video">www.ti.com/video</a>
Wireless	<a href="http://www.ti.com/wireless">www.ti.com/wireless</a>

Mailing Address: Texas Instruments, Post Office Box 655303, Dallas, Texas 75265  
Copyright © 2008, Texas Instruments Incorporated